

The Big Brown Bat

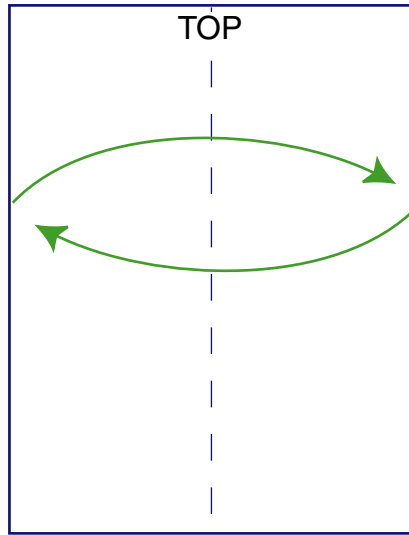

1 Fold a piece of paper in half lengthwise and crease. Open it flat.

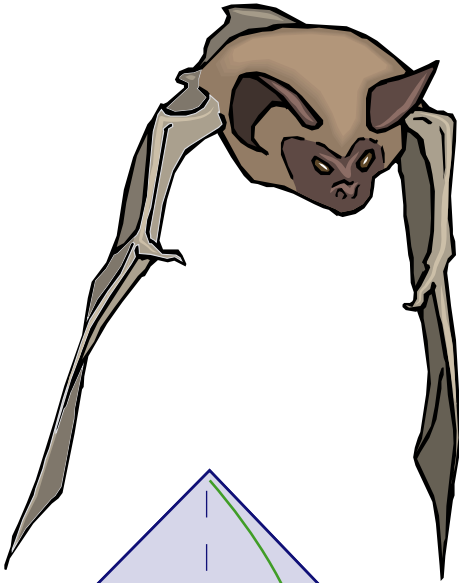
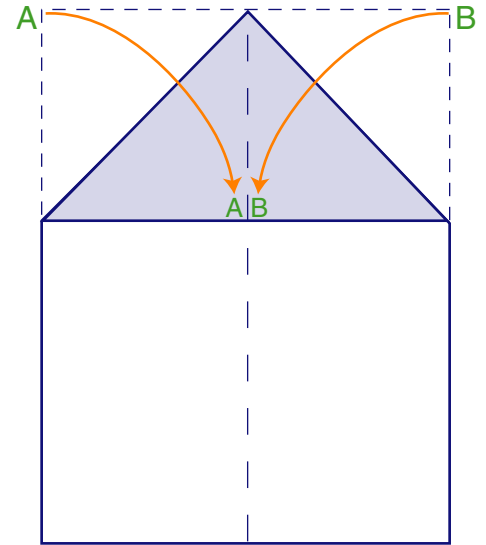

2 Fold corners **A** and **B** toward the center line to make a triangle.

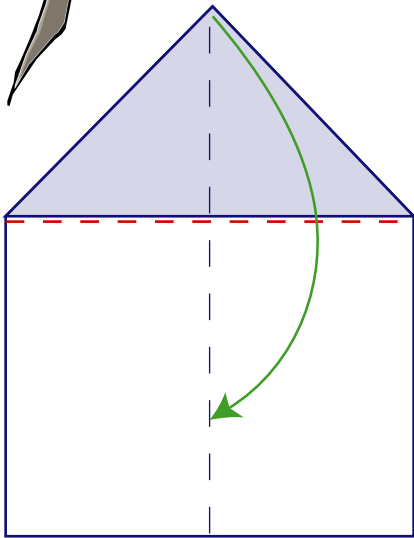

3 Fold the tip down along the **red fold line** so your plane looks like picture 3a. **3a**

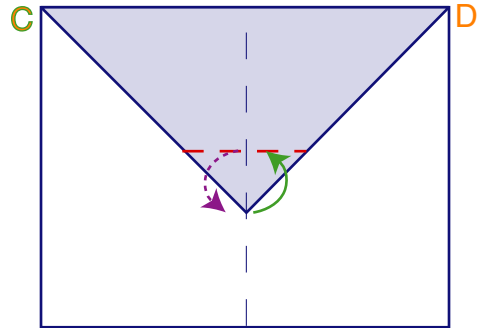
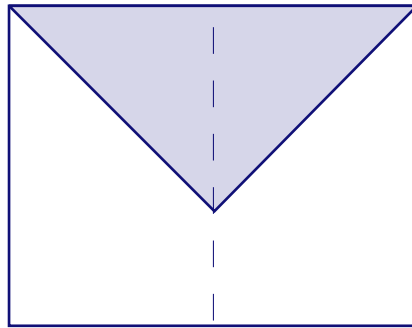

4 Fold about 1 inch of the tip up along the **red fold line** and **crease**; then **unfold**.

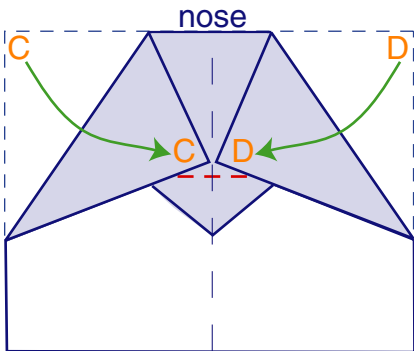

5 Fold corners **C** and **D** inward toward the center fold so your plane looks like this. Your plane should have a blunt nose.

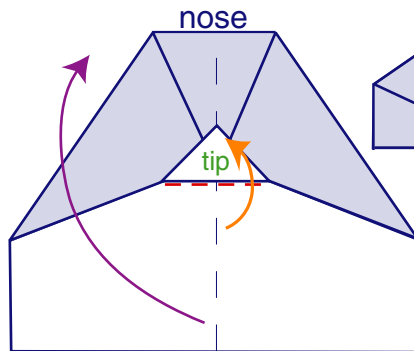

6 Fold the **tip** up along the **red fold line** to lock the wings in place. Fold the entire plane in half **backwards** along the center crease so the **tip** is on the outside and your plane looks like picture #7.

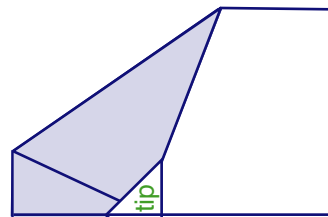

7

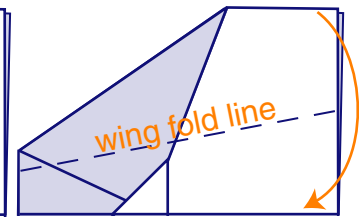

8 Fold the **top wing** even with the side of the plane. Flip over and repeat on the other side.

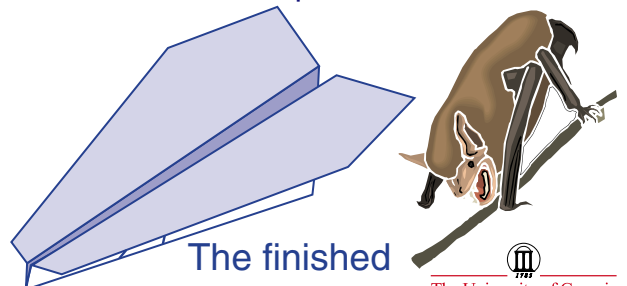

The finished **Big Brown Bat**

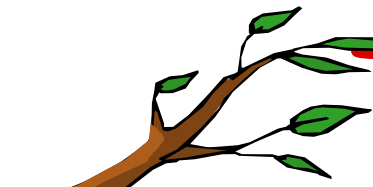

The Flying Squirrel

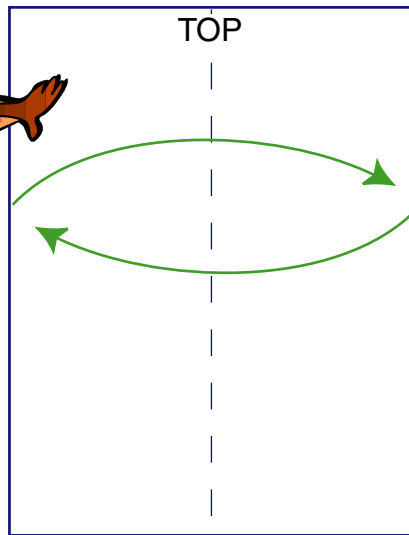

1 Fold a piece of paper in half lengthwise and crease. Open it flat.

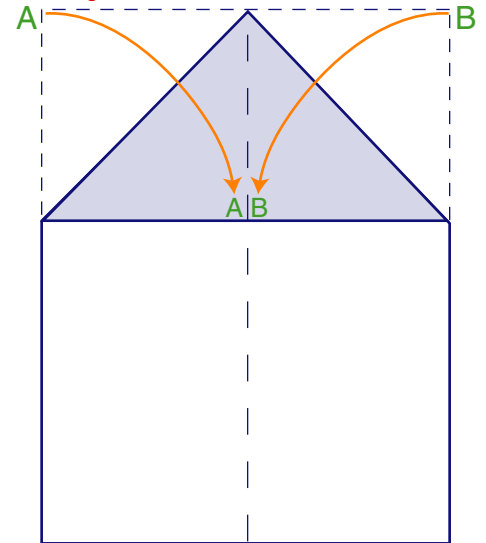

2 Fold corners A and B toward the center line to make a triangle.

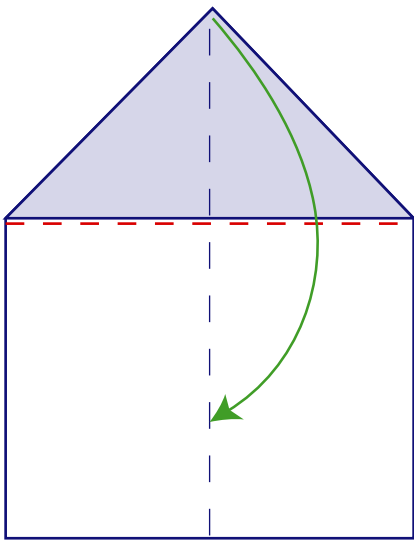

3 Fold the tip down along the red fold line so your plane looks like picture 3a.

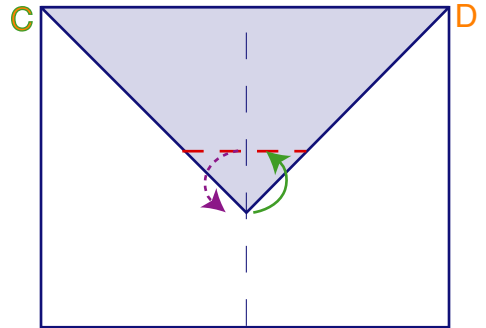
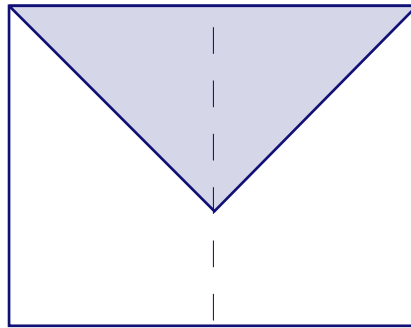

4 Fold about 1 inch of the tip up along the red fold line and crease; then unfold.

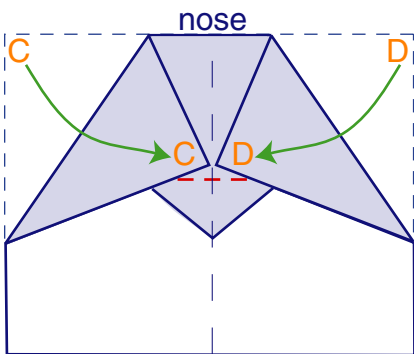

5 Fold corners C and D inward toward the center fold so your plane looks like this. Your plane should have a blunt nose.

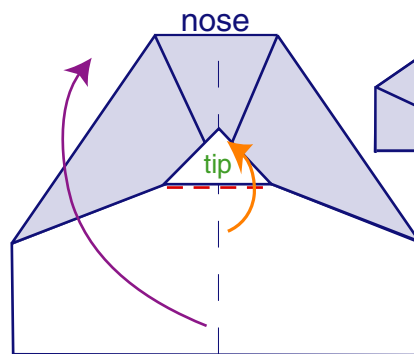

6 Fold the tip up along the red fold line to lock the wings in place. Fold the entire plane in half backwards along the center crease so the tip is on the outside and your plane looks like picture #7.

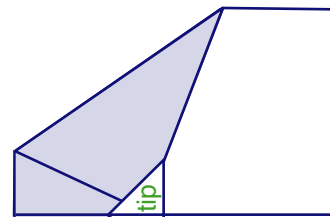

7

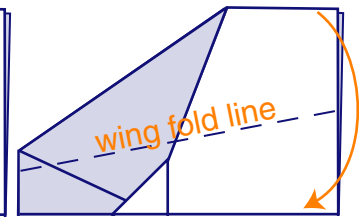

8 Fold the top wing even with the side of the plane. Flip over and repeat on the other side.



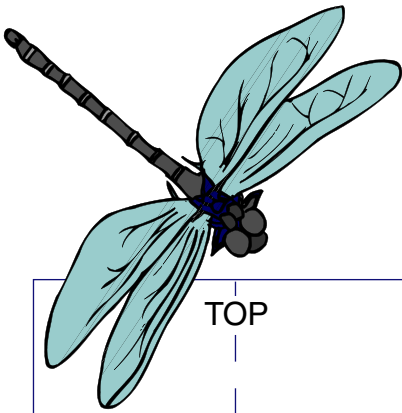

The Dragonfly

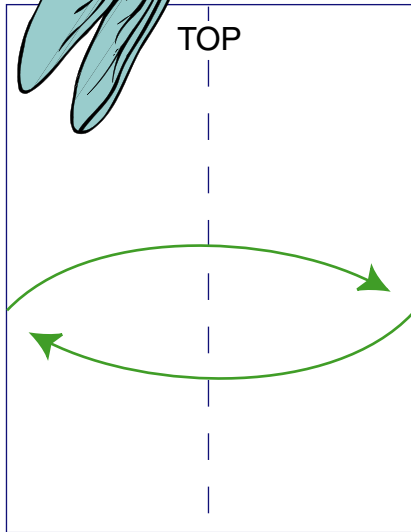

- 1 Fold a piece of paper in half lengthwise along the dotted line and crease. Open the paper flat.

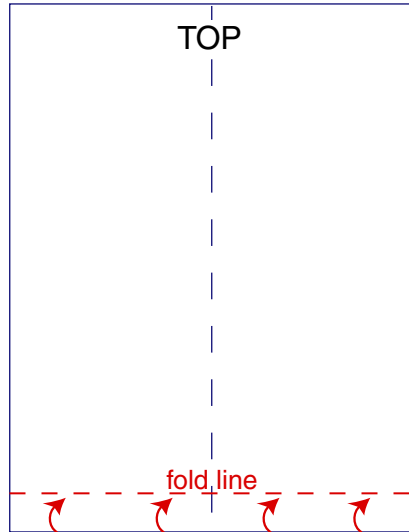

- 2 Fold the bottom of the paper up, about 2 cm. Crease along **fold line**.

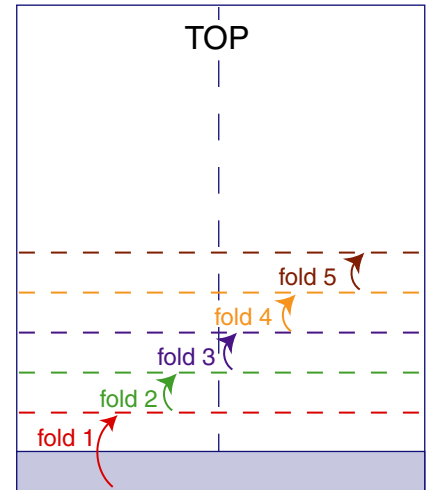

- 3 Fold the bottom of the paper up **5** more times, creasing along each turned-up edge.

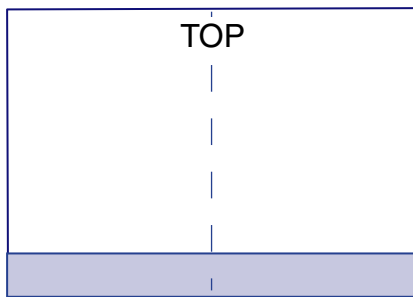

- 4 Your plane should now look like this.

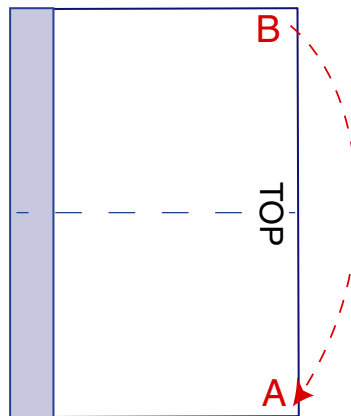

- 5 Turn your plane so it looks like this. Fold the plane in half backwards, matching up corners **A** and **B**.

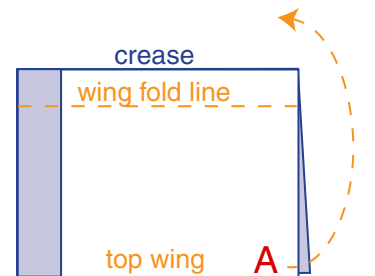

- 6 Fold the top wing **up** along the **wing fold line** and crease. Flip the plane over and repeat on the other side

- 7 Turn your plane over and the grasshopper is ready to fly.

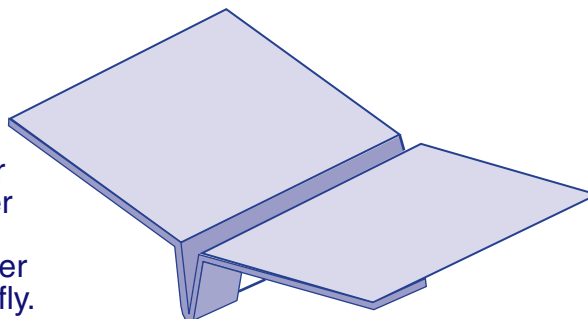

the finished Dragonfly



The Grasshopper

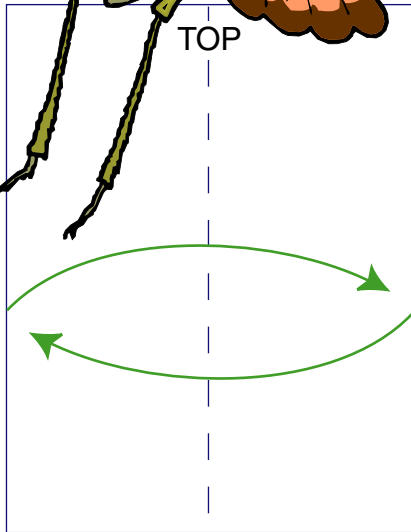
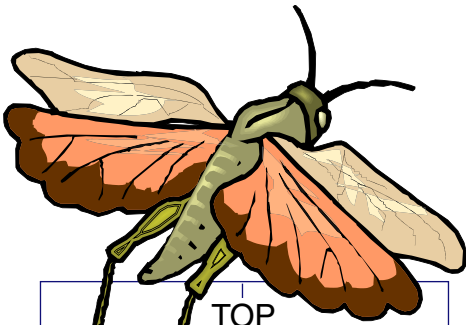

- 1 Fold a piece of paper in half lengthwise along the dotted line and crease. Open the paper flat.

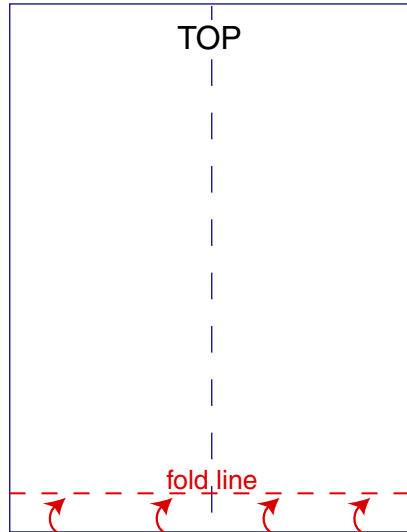

- 2 Fold the bottom of the paper up, about 2 cm. Crease along **fold line**.

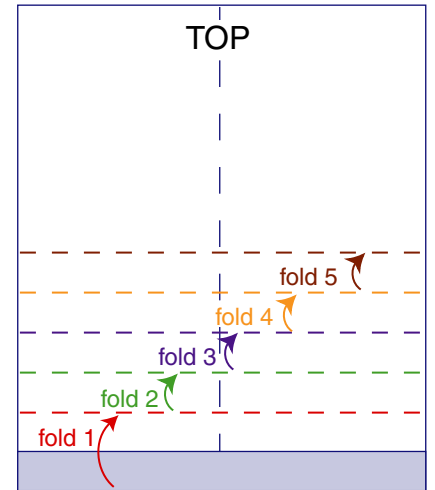

- 3 Fold the bottom of the paper up **5** more times, creasing along each turned-up edge.

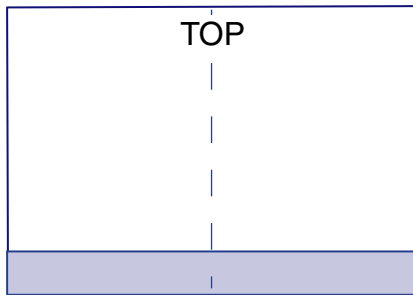

- 4 Your plane should now look like this.

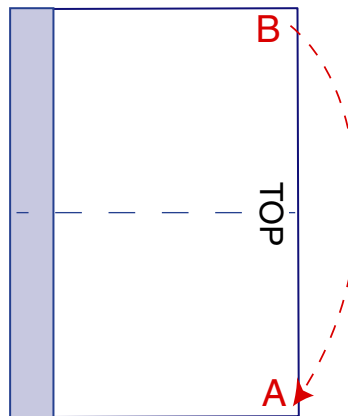

- 5 Turn your plane so it looks like this. Fold the plane in half backwards, matching up corners **A** and **B**.

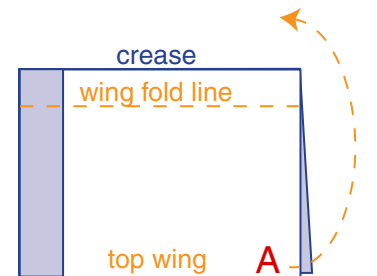

- 6 Fold the top wing **up** along the **wing fold line** and crease. Flip the plane over and repeat on the other side

- 7 Turn your plane over and the grasshopper is ready to fly.

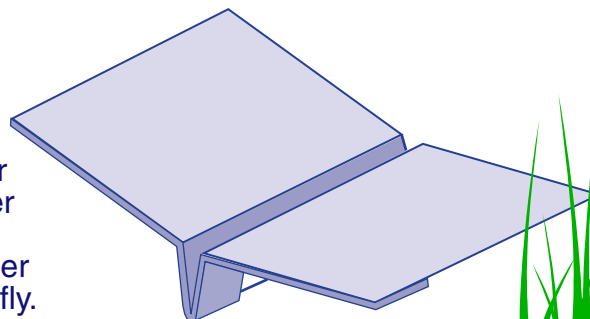

the finished Grasshopper

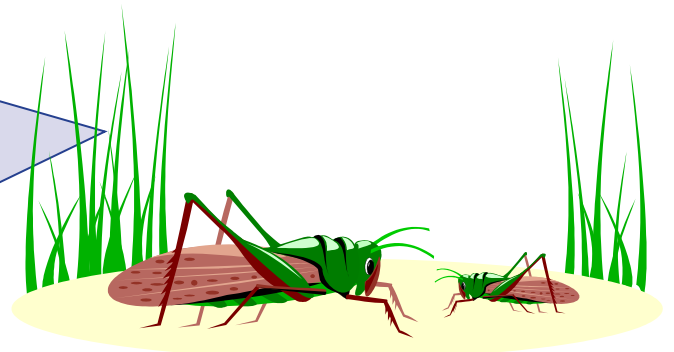

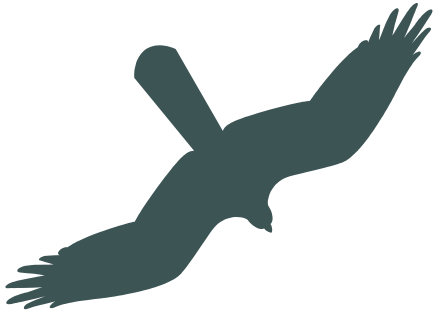

The Sparrow Hawk

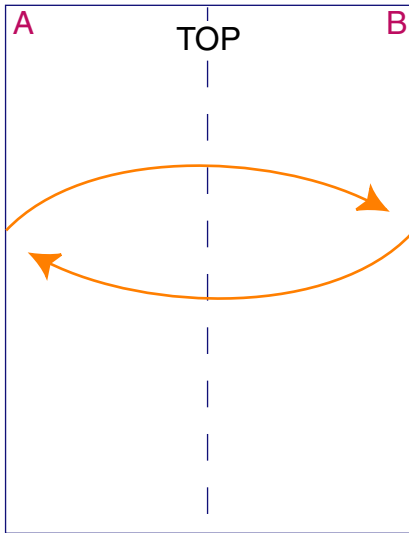
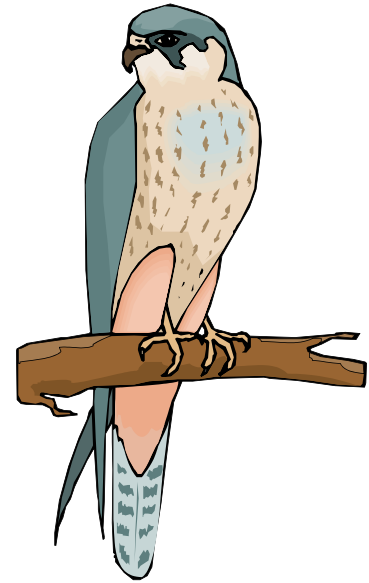

- 1 Fold a piece of paper in half lengthwise along the dotted line and crease. Open the paper flat.

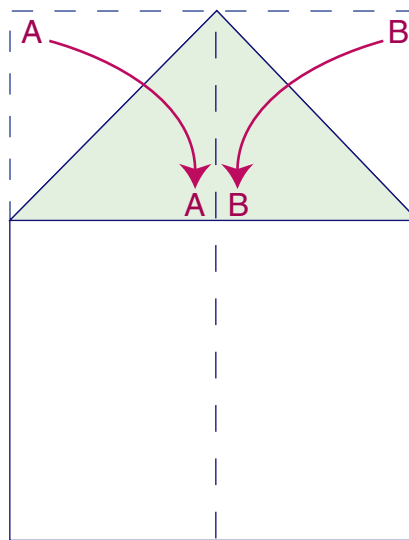

- 2 Fold corners **A** and **B** toward the center line to make a triangle. Crease.

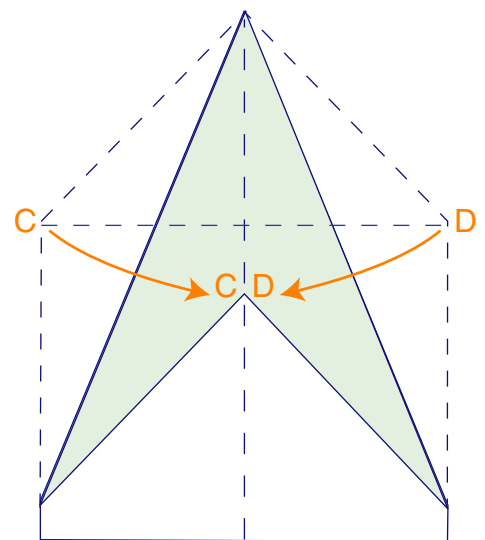

- 3 Fold corners **C** and **D** toward the center line to form another triangle. Crease.

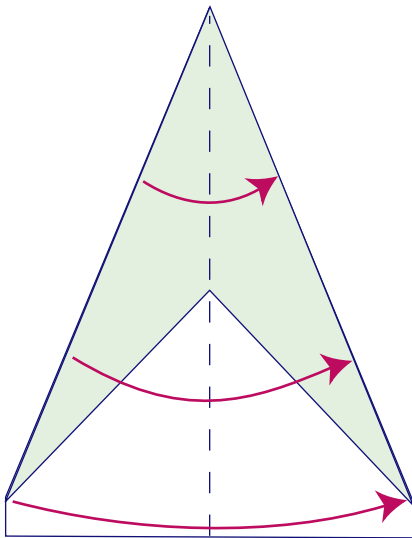

- 4 Fold the entire plane in half, inwards along the center crease.

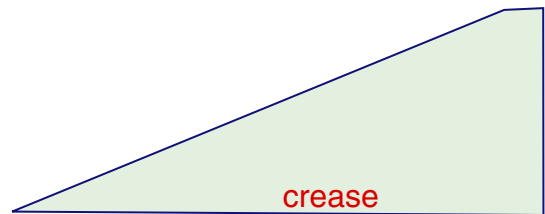

- 5 Rotate your plane so it looks like this. Make a sharp crease on the long bottom edge.

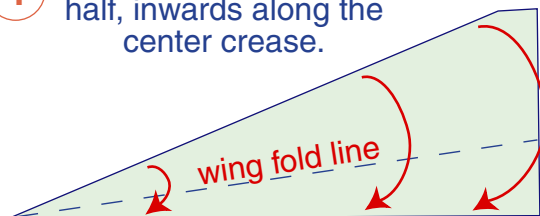

- 6 Fold the top wing down, even with the center line crease. Flip the plane over and repeat on the other side.

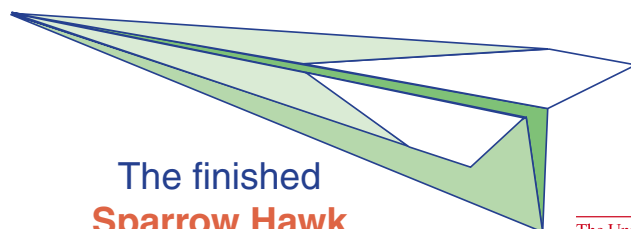

The finished Sparrow Hawk



The Bald Eagle

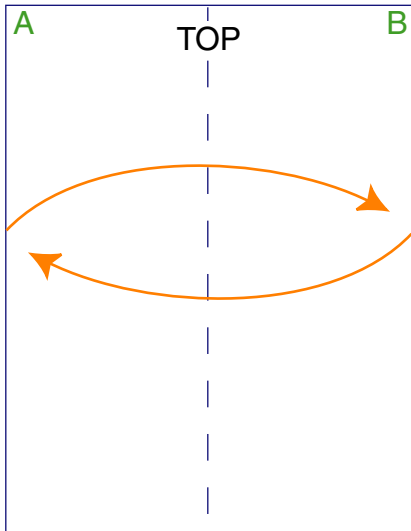
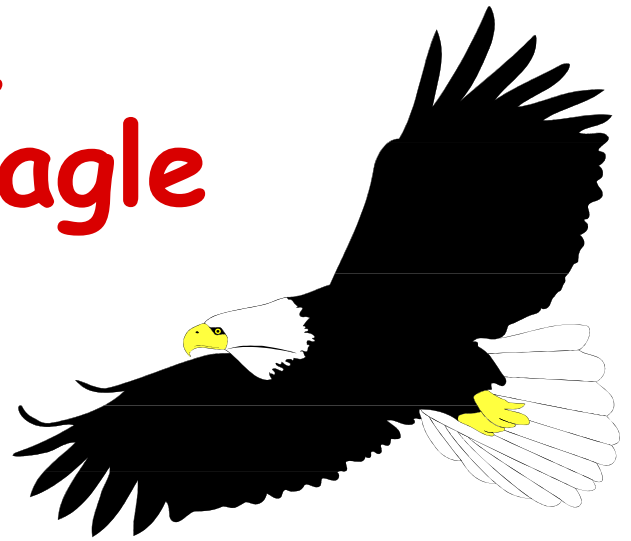

1 Fold a piece of paper in half lengthwise along the dotted line and crease. Open the paper flat.

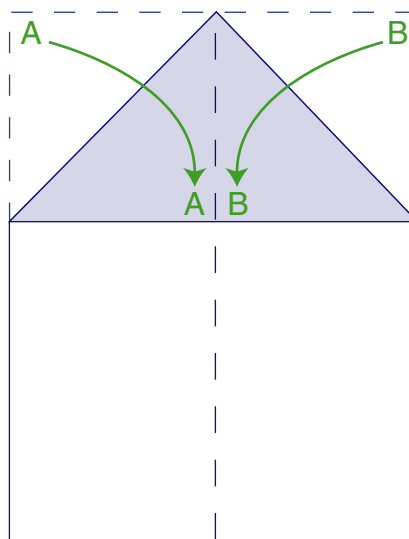

2 Fold corners **A** and **B** toward the center line to make a triangle. Crease.

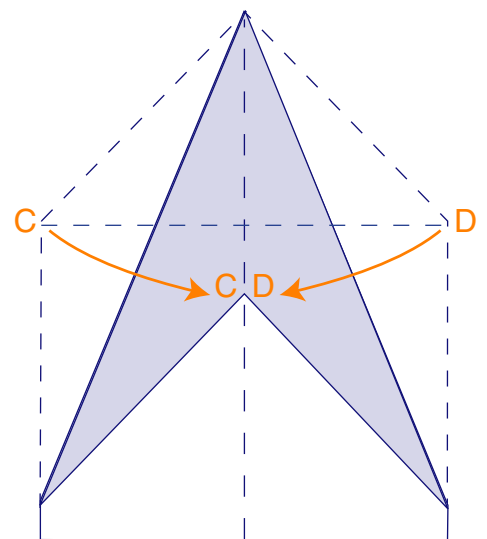

3 Fold corners **C** and **D** toward the center line to form another triangle. Crease.

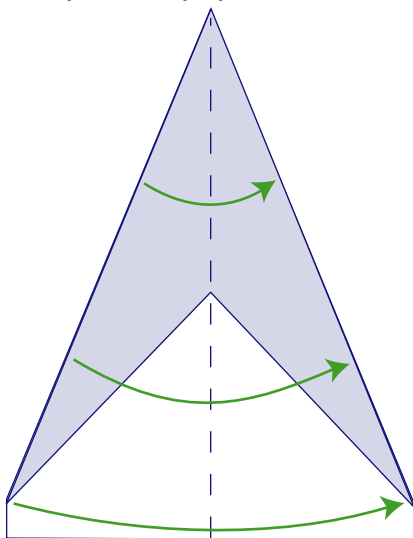

4 Fold the entire plane in half, inwards along the center crease.

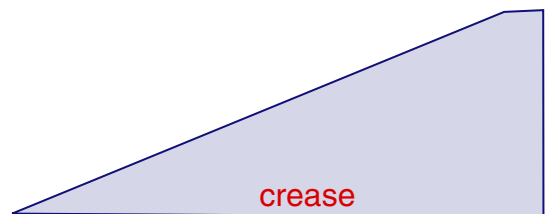

5 Rotate your plane so it looks like this. Make a sharp crease on the long bottom edge.

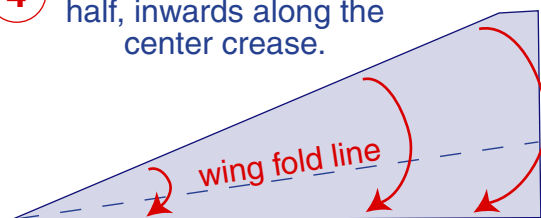

6 Fold the top wing down, even with the center line crease. Flip the plane over and repeat on the other side.

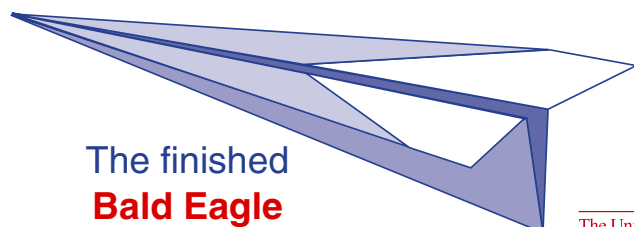

The finished **Bald Eagle**